

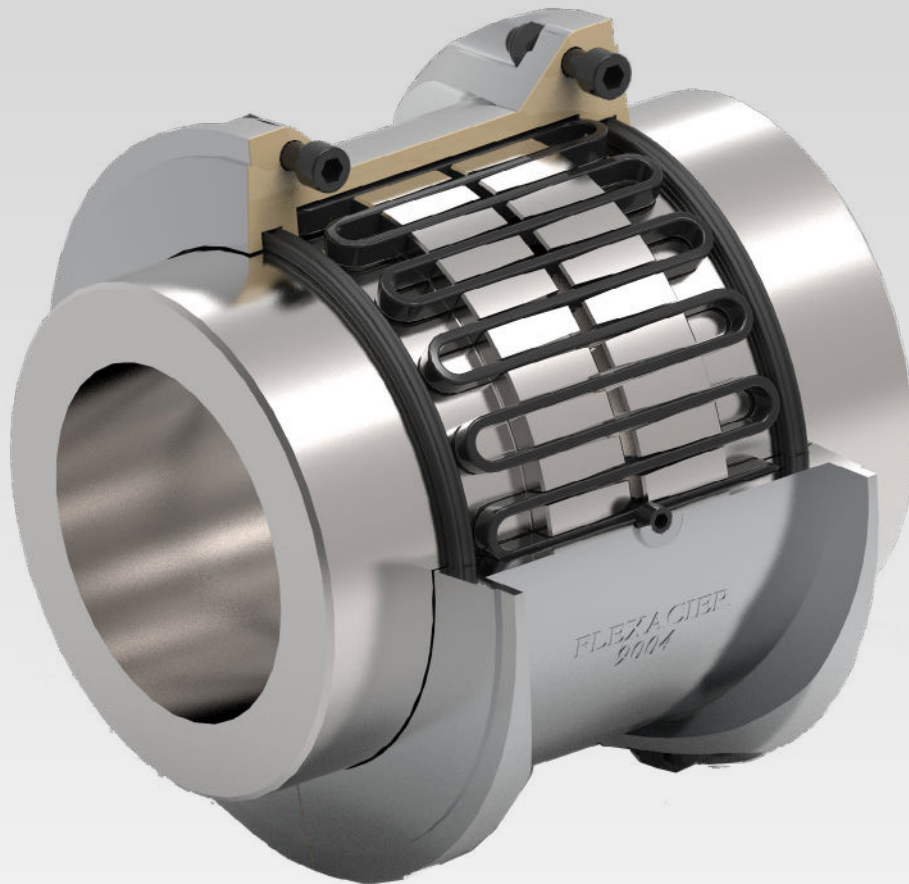

FLEXIBLE COUPLING

Winflex[®] 9000



www.cmd-couplings.com





Technical description

Flexacier 9000 is an all steel flexible coupling with grid elements.

A compact design for OEM's with a «quick fit» aluminum cast cover and standard hub lengths.

Torques from 950 to 26500 Nm for shaft diameters from 60 to 200 mm.

A robust design that allows shock & vibration absorption and increases the life span of the connected machines.

Long service life (based on CMD instructions for assembly, lubrication & maintenance for flexacier 9000, for an average life between maintenance operations up to 40.000 Hours or 5 years).



Applications

	FS
<i>Agitators, centrifugal fans, pumps & compressors, even load generators...</i>	1*
<i>Rotary compressors, bucket conveyors, rotary pumps, elevators...</i>	1,25
<i>Paper industries, winders/rewinders, light/medium duty conveyors, turbine/gears driven sugar mill stands...</i>	1,50
<i>Hammer mills, light/medium duty cranes, notching press, press, circular sawing machine, scrapers, calanders...</i>	1,75
<i>Small to medium cement kilns, wire mills, uneven load generators, edgers, heavy duty conveyors, rolls, heavy duty cranes, draw & wire benches, shears, sugar knives & crushers, cooling tower fans...</i>	2,00
<i>Strip mills, chippers, ball mills, internal & external mixers, rolling mills, heavy duty cement kilns, furnace feeders, strips, ingot machines...</i>	2,50
<i>Feed rolls, reciprocating pumps & compressors...</i>	3,00

* Only valid for installations with maximum torque less than 1.5 coupling base torque.

Dimensions

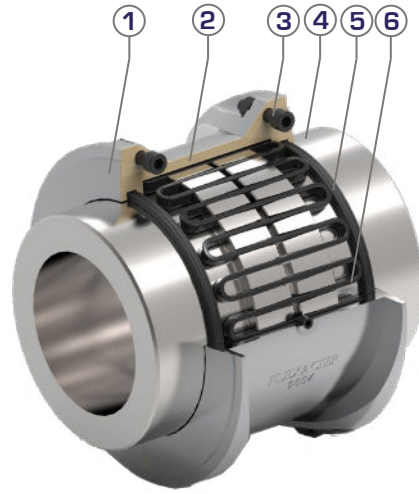
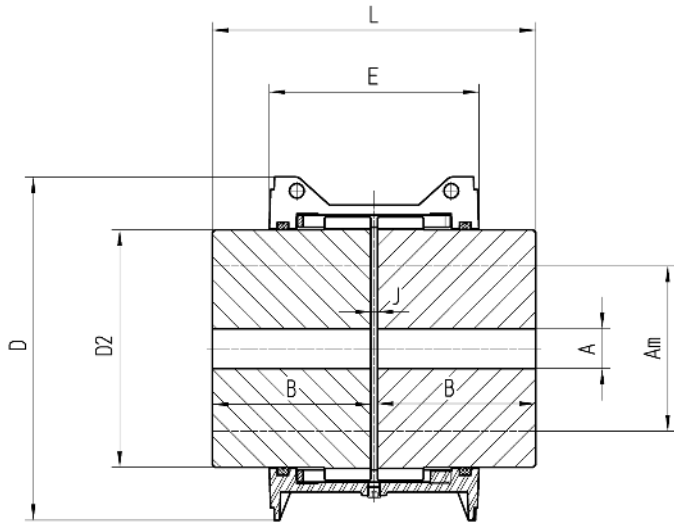







[Size 9004]

Item	Designation
1	Cover
2	Paper gasket
3	Fasteners
4	Hub
5	Rubber gasket
6	Grid set

Sizes 9000 to 9016

Horizontal or vertical working position

SIZES		9000	9001	9002	9004	9007	9009	9011	9016
Base torque	Nm	950	1900	3800	5700	9200	12700	18400	26500
Max.bore 	Am*	67	92	110	125	135	145	175	200
	Am**	60	80	100	110	120	135	160	180
Stock bore 	A	-	-	-	-	-	-	-	-
	B	76	88	98	120	127	149	162	184
	D	161	195	243	259,6	285,1	313,7	352,7	389,7
	D2	92	126	174	179,5	184,5	204	243	279
	E	107	107	107	158,8	158,8	163,2	163,2	163,2
	J	3 ^{+0,3} / _{-0,3}	3 ^{+0,3} / _{-0,3}	3 ^{+0,3} / _{-0,3}	5 ^{+0,5} / _{-0,5}	5 ^{+0,5} / _{-0,5}	6 ^{+0,6} / _{-0,6}	6 ^{+0,6} / _{-0,6}	6 ^{+0,6} / _{-0,6}
	L	155	179	199	245	259	304	330	374
Number of grid elements		2	2	2	2	4	4	4	4
Number of layers		1	1	1	1	2	2	2	2
Coupling weight 	Kg	10,9	21	41,6	56,6	67,4	93	132	193
Grid set + cover weight 	Kg	1,9	2,4	3,2	5,6	9	11,2	13	15
Moment of inertia 	kgm ²	0,017	0,054	0,176	0,281	0,412	0,666	1,292	2,332
Max. speed 		3100	2700	2200	1800	1700	1500	1350	1240
	y	4125	3600	3000	2440	2250	2025	1800	1650
Lube weight 	kg	0,13	0,18	0,27	0,40	0,70	0,80	1	1,20

* Bore with keyway
** Shrink fitting

● Solid hubs
y Dynamically balanced
▽ Per coupling



For any QUERY or REQUEST for quotation:
couplings@cmdgears.com



French design & manufacture



HEAD OFFICE
& CAMBRAI PLANT
539, Avenue du Cateau
59400 CAMBRAI
FRANCE

SALES OFFICE
36, Avenue de l'Europe
Immeuble de l'Etendard BP43
78142 VELIZY-VILLACOUBLAY
FRANCE
+33 (0)1 34 63 12 24